

Hotel Service

Optimised day-to-day hotel processes





Content

A SUCCESS STORY	5	02 FRONT OFFICE	40
HIGHLIGHTS_MADE BY WANZL	7	01 Luggage collection trolley GS-Trend	42
OVERVIEW	8-9	02 Luggage collection trolley GS-Lobby	44
01 HOUSEKEEPING	10	03 Luggage collection trolley GS-Group	45
Chambermaid trolley dimensions	13	04 Luggage collection trolley GS-Compact	46
01 Chambermaid trolley Premium ZP Classic	14	05 Luggage transport trolley Aera 300 L	47
02 Chambermaid trolley Premium ZP Eco	16	06 Luggage transport trolley Voyager 3000	48
03 Chambermaid trolley Premium ZP Clean	18	07 Luggage transport trolley Travel 300	49
04 Chambermaid trolley Premium ZP Basic	20	08 Luggage transport trolley Easy 400	50
Chambermaid trolleys – Order parts	22	09 Part Flex 2000	51
Chambermaid trolleys –Accessories	23	10 Part Line 2000	52
05 Chambermaid trolley Premium ZP-5 Fresh	24	03 FOOD + BEVERAGES	54
05 Chambermaid trolley Premium ZP-5 Clean	25	01 Minibar filling trolley Premium MBW-Smart	56
05 Premium ZP-5 Fresh + Clean	26	02 Minibar filling trolley Premium MBW-Secure	58
06 Linen trolley SW 80	28	03 Banquet service trolley Premium-BS	60
07 Linen trolley SW 145 KX	29	04 Room-service table RSVC-Comfort	61
08 Linen trolley SW 240	30	05 Serving trolleys EG 200 · EG 300	62
09 Linen trolley SW 3-110	31	06 Serving trolleys EU 200 · EU 300	63
10 Sprung-base trolley AL	32	07 Tray trolley TBL 20	64
11 Shelved laundry container AL	33	08 Tray trolley TB 16	65
12 Mobile container RC/S8	34	09 Plate trolley TW-Classic	66
13 Mobile container RC/N2	35	10 Plate trolley TW-Poly	67
14 Transport baskets, mobile, TK-R and TK-D	36	11 Single-plate trolley TW-Solo	68
15 Room-change trolley RCW	37	12 Bottle trolleys FW-8 · FW-16	69
16 Clothes stand GR	38	04 STORAGE + SHELVING	70
17 Case stand KS 600	39	01 Service shelf High rack	72
		High rack order part	73
		02 Transport trolleys T2 and W 71 E	74
		03 Ski and snowboard stands	75



Wanzl Hotel Service

Continuing a long success story



Plate trolley 1976

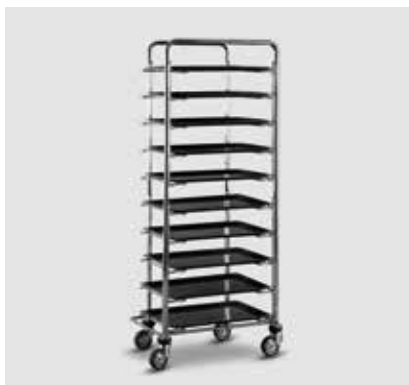

Tray trolley 1984



ZP Classic chambermaid trolley 2012

■ **At Wanzl, we know** what people will want tomorrow. As a world market leader for shopping trolleys, we provide the right answers for Hotel Service too. As early as the 1970s, the first Hotel Service products were already being produced, such as the plate and tray trolleys for optimised day-to-day processes in the hotel and catering trade.

■ **Today, Wanzl employs** over 4,000 employees at eleven production sites worldwide, working on new business areas and products, on unusual product designs with a consistently high quality and a vast production range. The aim: perfectly satisfied customers.

The world is changing. Take advantage of it!

■ **For optimised day-to-day hotel processes.** Wanzl's professional competence ensures effective work processes in the hotel and catering trade – and thus also the competitiveness and business success of its partners. Functional, economical and user-friendly products minimise personnel requirements and help to satisfy the high expectations and requirements of your guests.



Highlights_MADE BY WANZL

Innovative products from a single source



In-house castor production



In-house CAD development

Production

■ **Wanzl sets the standards for production:** in all production processes, Wanzl's quality policy results in products with the best materials, first-class workmanship and well-finished surfaces. This ensures long-term maintenance-free use and investment security.

Quality

■ **Wanzl sets the standards for quality:** particularly with regard to smooth motion: the castors are mounted on two maintenance-free ball bearings, have abrasion-proof treads and feature steering forks with ball bearings. As a result, our chambermaid trolleys are quiet, smooth-running and easy to steer.

Innovation

■ **Wanzl sets the standards for innovation:** from practical experience – for practical use: Using cutting-edge production and design technology, we create innovative, forward-looking products and constantly set new standards for handling and effectiveness. In this way we streamline your processes, guaranteeing you have the best possible facilities in the future, too.





HOUSEKEEPING

01

FRONT OFFICE

02

FOOD + BEVERAGES

03

STORAGE + SHELVING

04



01 Product overview

01.01 – 01.05 Premium chambermaid trolleys



01 ZP CLASSIC



02 ZP ECO



03 ZP CLEAN



04 ZP BASIC



05 ZP-5 FRESH + ZP-5 CLEAN

01.06 – 01.09 Linen trolleys



06 SW 80



07 SW 145 KX



08 SW 240



09 SW 3-110

01.10 – 01.14 Mobile containers and transport baskets

10 SPRUNG-BASE
TROLLEY AL11 SHELVED LAUNDRY
CONTAINER AL

12 RC/S8



13 RC/N2



14 TK-R + TK-D

01.15 – 01.17 Room-change trolleys, coat racks and case stands



15 RCW



16 GR



17 KS 600

01 Housekeeping

01

02

03

04





01.01-04 Overview – Dimensions

ZP-7 Premium ZP Classic Premium ZP Eco Premium ZP Clean

Dimensions (mm): Castors \varnothing 200
Loading capacity:
Trolley shelves max. 50 kg each
Trolley side parts max. 20 kg each

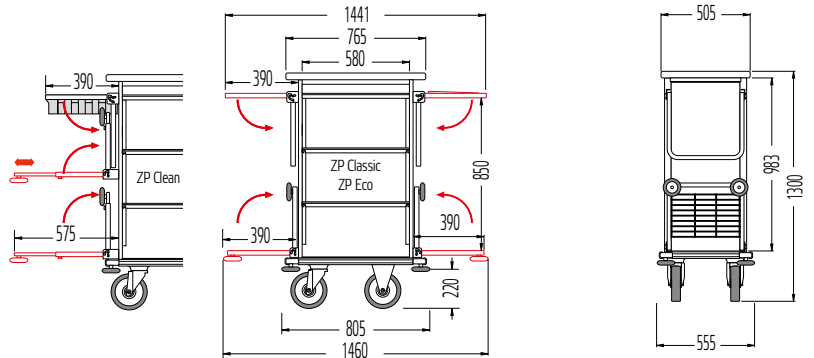

ZP-9 Premium ZP Classic Premium ZP Eco Premium ZP Clean

Dimensions (mm): Castors \varnothing 200,
5th castor \varnothing 160
Loading capacity:
Trolley shelves max. 50 kg each
Trolley side parts max. 20 kg each

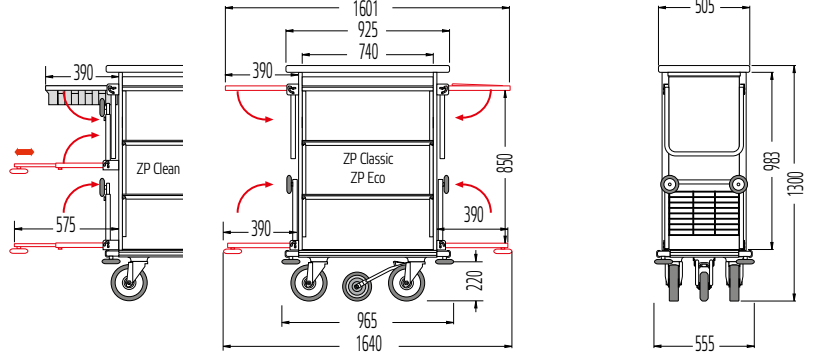

ZP-11 Premium ZP Classic Premium ZP Eco Premium ZP Clean

Dimensions (mm): Castors \varnothing 200,
5th castor \varnothing 160
Loading capacity:
Trolley shelves max. 50 kg each
Trolley side parts max. 20 kg each

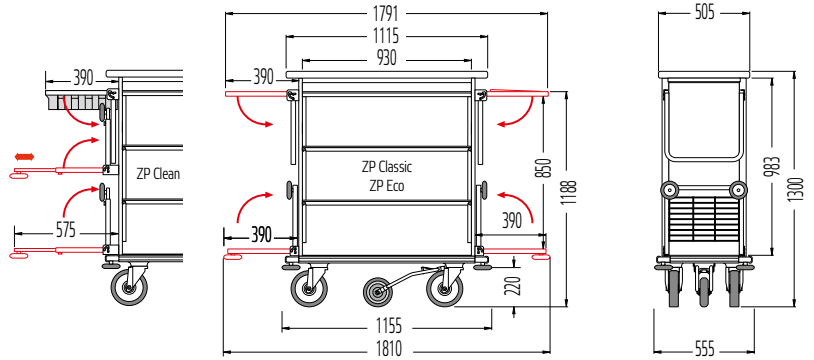

ZP-9 Premium ZP Basic

Dimensions (mm): Castors \varnothing 125
Loading capacity:
Trolley shelves max. 50 kg each
Trolley side parts max. 20 kg each

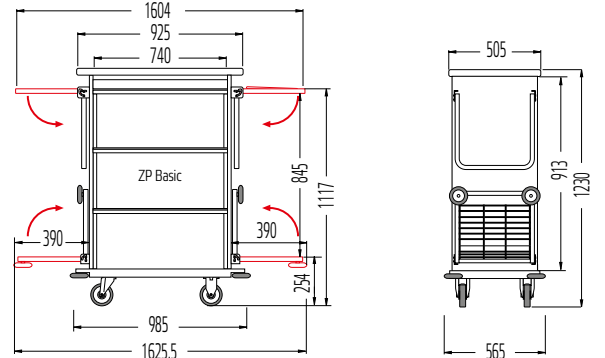

01.01 Premium ZP Classic

Perfect room service

- > Agile and easy to manoeuvre thanks to the innovative 5th castor
- > With all-round bumper profile and integrated deflectors to protect your inventory
- > Adaptable: available in 3 sizes and 3 finishes



Design pend.

Finish



ZP-9 CLASSIC
Anthracite finish
Illustration shows special equipment

01.01 Premium ZP Classic

The tried-and-tested design from Wanzl

■ The special features of the Premium Classic chambermaid trolley help the room service personnel to provide a perfect service. It can be customised as required by adding practical accessories.

Standard equipment: Steel-tube design, fold-out bars for hanging laundry and rubbish bags, one of which is a bar with folding lid for closing 120-litre plastic bags. Lower bars, each with grate. Two fixed and two height-adjustable shelves in matching finish.

Finish: Plastic powder-coated in titanium grey.

Model ZP-7: 2 swivel castors, 2 fixed castors, with polyamide treads.

Models ZP-9, ZP-11: 4 swivel castors with polyamide tread, 5th central castor with rubber tread.



Design pend.

ZP-9 CLASSIC
Anthracite finish
Illustration shows special equipment

5th castor – extremely manoeuvrable

Simply perfect: The 5th castor allows the trolley to rotate on the spot. Available for the ZP-9 and ZP-11 models.



All-round protection for your hotel interior

Protective feature: Integrated deflector profile and rubber deflectors protect the hotel interior.



Accessories: Polyester cover for rubbish bag

Visually and functionally perfect: "Invisible" rubbish bag thanks to polyester cover. A much nicer look.



01.02 Premium ZP Eco

Room service meets environmental awareness

- > *Simple waste separation*
- > *2 waste separation boxes as standard*
- > *Adaptable: available in 3 sizes and 3 finishes*



Design pend.

Finish



ZP-9 ECO
Anthracite finish
Illustration shows special equipment

01.02 Premium ZP Eco

The environmentally friendly design from Wanzl

■ The special features of the Premium Eco chambermaid trolley are particularly helpful for separating waste. It, too, can be upgraded with practical accessories.

Standard equipment: Steel-tube design, fold-out bars for hanging laundry and rubbish bags, one of which is a bar with folding lid for closing 50-litre plastic bags. Lower bars, each with grate. Two stackable waste separation boxes with lid. Two fixed and two height-adjustable shelves in matching finish.

Finish: Plastic powder-coated in titanium grey.

Model ZP-7: 2 swivel castors, 2 fixed castors, with polyamide treads.

Models ZP-9, ZP-11: 4 swivel castors with polyamide tread, 5th central castor with rubber tread.



Design pend.

ZP-9 ECO
Anthracite finish
Illustration shows special equipment

Practical clamp fastening

Convenient details

Clamp fastening ensures the rubbish bag is held securely.



Waste separation boxes as standard

Simple waste separation

2 standard boxes allow different recyclable materials to be separated easily.



Adjustable shelf

Inserted without tools:

The shelf can be easily set at the desired height.



Optional ash boxes

Prevents odours

The lid also avoids odours escaping when providing room service.



01.03 Premium ZP Clean

Room service with the ultimate in hygiene

- > *Cleaning made easy*
- > *Retaining net for holding a cleaning tray*
- > *Extendible trays for customised storage space*



ZP-9 CLEAN
Anthracite finish
Illustration shows special equipment

Finish



01.03 Premium ZP Clean

The clean design from Wanzl

■ The special features of the Premium Clean chambermaid trolley helps make cleaning more efficient.

Like all premium models, it can be upgraded with practical accessories.

Standard equipment: Steel-tube design. Two fixed and two height-adjustable shelves in matching finish.

Right-hand side: fold-out bar for hanging a rubbish bag. Lower bar with grate and 2 stackable waste separation boxes with lids.

Left-hand side: adaptable equipment with extendible, pull-out shelves and a retaining net for cleaning materials.

Finish: Plastic powder-coated in titanium grey.

Model ZP-7: 2 swivel castors, 2 fixed castors, with polyamide treads.

Models ZP-9, ZP-11: 4 swivel castors with polyamide tread, 5th central castor with rubber tread.



ZP-9 CLEAN
Anthracite finish
Illustration shows special equipment

Shelves and grates

Equipment options

Top

- Fold-out retaining net for cleaning materials

Middle, choice of

- Extendible, fold-out shelf with locking pegs or
- Fold-out grate, or
- Fold-out retaining net for cleaning materials

Bottom, choice of

- Fold-out extendible shelf or
- Fold-out grate



Optional utensils pocket

Made from polyester

As practical as it gets. For items which always need to be in the same place, easy to pick up quickly.

Whether it's guest supplies or cleaning materials, just as you like.



01.04 Premium ZP Basic

Room service – extra economical

> *Practical basic equipment*

> *With all-round bumper profile and integrated deflectors to protect your inventory*

> *Platinum white finish*



ZP-9 BASIC
Platinum white finish
Illustration shows special equipment

01.04 Premium ZP Basic

The cost-saving design from Wanzl

■ The practical features of the “Premium” Basic chambermaid trolley also offer a cost-saving budget option, with the usual Wanzl quality.



Standard equipment: Steel-tube design, fold-out bars for hanging laundry and rubbish bags, one of which is a bar with folding lid for closing 120-litre plastic bags. Lower bars, each with grate. Three fixed shelves, platinum white finish.

Finish: Plastic powder-coated in titanium grey.

Castors: 2 swivel castors, 2 fixed castors with polyamide tread, castors ø 125 mm.



ZP-9 BASIC
Platinum white finish
Illustration shows special equipment

Fold-out side parts

Providing flexibility

In confined spaces. A practical solution to save space.



Deflectors

Effective protection

Deflectors protect your interior décor from damage.



01.01-04 Order part

Classic, Eco, Clean and Basic chambermaid trolleys

Models		ZP-7	ZP-9	ZP-11
Dimensions		765 x 527 x 1300	925 x 527 x 1300	1115 x 527 x 1300
		Order no.	Order no.	Order no.
ZP Premium Classic	anthracite, alder or wenge finish	04.01 244.95-V	04.01 245.95-V	04.01 246.95-V
ZP Premium Eco	anthracite, alder or wenge finish	04.01 247.95-V	04.01 248.95-V	04.01 249.95-V
ZP Premium Clean	anthracite, alder or wenge finish	04.01 257.95-V	04.01 258.95-V	04.01 259.95-V
ZP Premium Basic	platinum white finish	-	04.01 240.95-0000	-

Special equipment				
Lockable lid	anthracite, alder or wenge finish	<input checked="" type="checkbox"/>	<input checked="" type="checkbox"/>	<input checked="" type="checkbox"/>
Additional shelves	anthracite, alder or wenge finish	<input checked="" type="checkbox"/>	<input checked="" type="checkbox"/>	<input checked="" type="checkbox"/>
Drawer, plastic powder-coated in titanium grey		<input checked="" type="checkbox"/>	<input checked="" type="checkbox"/>	<input checked="" type="checkbox"/>
Drawer compartment divider		<input checked="" type="checkbox"/>	<input checked="" type="checkbox"/>	<input checked="" type="checkbox"/>
Lockable plastic roll-down panel, in silver		<input checked="" type="checkbox"/>	<input checked="" type="checkbox"/>	<input checked="" type="checkbox"/>
Bag holder, extended, incl. 2 polyester bags		<input checked="" type="checkbox"/>	<input checked="" type="checkbox"/>	<input checked="" type="checkbox"/>
Double rubbish bag holder, plastic powder-coated in titanium grey		<input checked="" type="checkbox"/>	<input checked="" type="checkbox"/>	<input checked="" type="checkbox"/>
Castors with rubber tread (1 set)		<input checked="" type="checkbox"/>	<input checked="" type="checkbox"/>	<input checked="" type="checkbox"/>
For chambermaid trolleys with roll-down panel				
Additional shelves, shortened	anthracite, alder or wenge finish	<input checked="" type="checkbox"/>	<input checked="" type="checkbox"/>	<input checked="" type="checkbox"/>
Accessories				
Wooden box for small items, pearl light grey varnished		00.21 837.78-9022	00.21 837.78-9022	00.21 837.78-9022
Wooden box for small items, transparent varnished		00.60 694.78-0000	00.60 694.78-0000	00.60 694.78-0000
Top box, metal, plastic powder-coated in titanium grey		04.03 504.73-7084	04.03 504.73-7084	04.03 504.73-7084
Adjustment option for top box		1	1	2
Waste separation box, silver-grey plastic		04.06 555.07-0000	04.06 555.07-0000	04.06 555.07-0000
Lid for waste separation box, silver-grey plastic		04.06 668.07-0000	04.06 668.07-0000	04.06 668.07-0000
Ash box, metal, plastic powder-coated in titanium grey		00.22 176.73-7084	00.22 176.73-7084	00.22 176.73-7084
Brochure holder, metal, plastic powder-coated in titanium grey		00.22 289.73-7084	00.22 289.73-7084	00.22 289.73-7084
Bags for repeat order		Order no.	Order no.	Order no.
Utensils pocket, polyester, grey		00.22 515.00-0000	00.22 515.00-0000	00.22 515.00-0000
Polyester bag, grey, 110 litres, 1 unit		00.22 402.00-0000	00.22 402.00-0000	00.22 402.00-0000
Polyester bag, beige, 110 litres, 1 unit		00.36 979.00-0000	00.36 979.00-0000	00.36 979.00-0000
Plastic bag, grey, 50 litres, 1 pack containing 15 units		00.22 741.00-0000	00.22 741.00-0000	00.22 741.00-0000
Plastic bag, blue, 50 litres, 1 pack containing 15 units		00.23 080.00-0000	00.23 080.00-0000	00.23 080.00-0000
Plastic bag, grey, 120 litres, 1 pack containing 25 units		00.24 436.00-0000	00.24 436.00-0000	00.24 436.00-0000

01.01-04 Overview

Special equipment

- ① **Lockable lid**
- ② **Lockable roll-down panel**
- ③ **Extra drawer**
- ④ **Extra shelf**

Lots of space for all the utensils you need.



- ⑤ **Rubber castor**
- ⑥ **Double rubbish-bag holder**

Quiet when moving, the perfect castors for stone flooring.

Waste separation made truly easy when providing room service.

- ⑦ **Holder**
- Bulky cleaning utensils** are therefore stored safely and securely.

Accessories

- ⑧ **Top box**
- ⑨ **Utensils pocket**
- ⑩ **Polyester cover**
- ⑪ **Small items box**
- ⑫ **Ash box**
- ⑬ **Brochure holder**

High-value goods transported safely.

Accessories for even more space to accommodate more utensils.

Visually and functionally perfect to keep the rubbish bag hidden.

Even more organisation space for extra utensils.

Odours are eliminated.

Ready to hand for presenting your image with brochures.

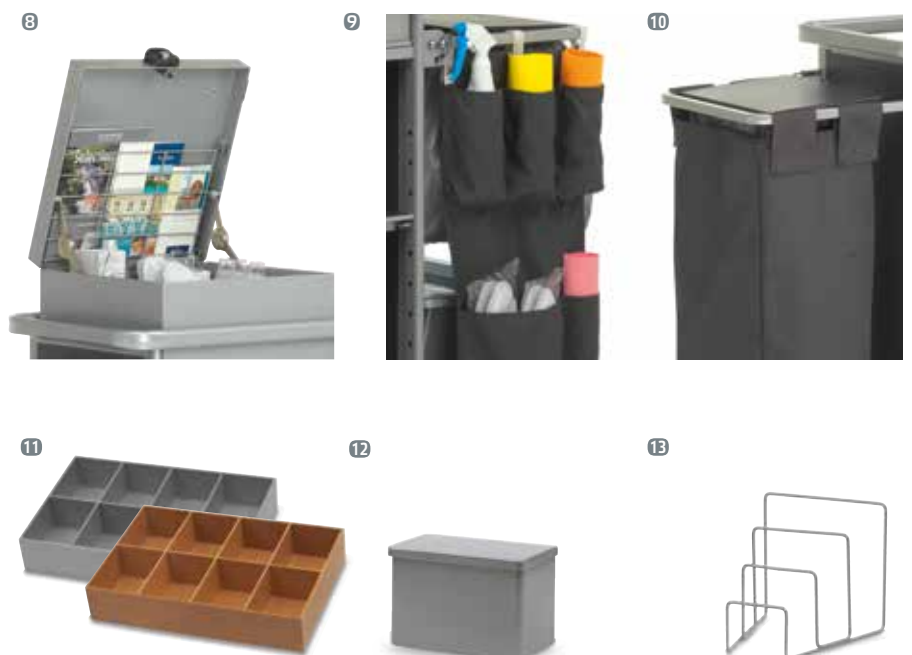

01.05 Premium ZP-5 Fresh

Several possible uses

> For evening housekeeping checks / turn-down service

> For building and utilities management / public areas

> For the events area



ZP-5 FRESH*
Anthracite finish
Illustration shows special equipment

Design pend.
Pat. pend.



* Image shows trolley with standard equipment and optional box for small items

Standard equipment

Stylish steel tube construction with retractable sideways doors. Chassis with all-round bumper profile and four plastic deflectors. 1 pull-out drawer with damped retraction, 2 height-adjustable shelves, top storage area features all-round rail, fixture for docking a further module, optional connector.

Finish

Plastic powder-coated in titanium grey, anthracite finish.

Castors

4 double swivel castors with rubber tread, incl. 2 with brakes.

01.05 Premium ZP-5 Clean

The perfect companion to the ZP-5 Fresh

> *Inconspicuous room service*

> *Adjustable holder for rubbish bag*

> *Adjustable storage thanks to individually-adjustable holders*

01

02

03

04



ZP-5 CLEAN
Anthracite finish
Illustration shows special equipment

Design pend.
Pat. pend.

Standard equipment

Stylish steel tube construction with retractable sideways doors. Chassis with all-round bumper profile and four plastic deflectors. 2 built-in, upwards-opening flaps for rubbish and laundry bags. Inside: height-adjustable holder for plastic bag (for rubbish, 30* to 60-litre volume optionally available) and fixed holder for polyester bag (for laundry, 55-litre volume).

* Standard

Finish

Plastic powder-coated in titanium grey, anthracite finish.

Castors

4 double swivel castors with rubber tread, incl. 2 with brakes.

01.05 Premium ZP-5 Fresh+Clean

Room service in pairs

> *Quick to dock*

> *Functional and aesthetic*

> *Highly manoeuvrable*



ZP-5 FRESH
Anthracite finish
Illustration shows special equipment

ZP-5 CLEAN - DOCKED
Anthracite finish
Illustration shows special equipment

01.05 Premium ZP-5 Fresh+Clean

Flexible premium combination from Wanzl

■ The nimble Premium ZP-5 Fresh and Premium ZP-5 Clean chambermaid trolleys: together, they combine functionality and aesthetics.

ZP-5 Fresh + Clean Effective protection

Deflectors and bumper rails protect your interior décor from damage.



ZP-5 Fresh + Clean Fast docking

The optional connector allows the ZP-5 Fresh and the ZP-5 Clean to be easily combined.



ZP-5 Fresh with robust railing

For safe manoeuvring and to create extra storage space.



ZP-5 Clean with lid

2 upwards-opening lids to provide a visual cover and to prevent odours escaping.



ZP-5 Fresh with 2nd drawer

The optional standard equipment for the ZP-5 Fresh also includes a 2nd drawer.



ZP-5 Fresh + Clean with adjustable shelf

Adjustable to any height to optimise the space needed for laundry or guest supplies.



Dimensions in mm
Castors ø 100 mm

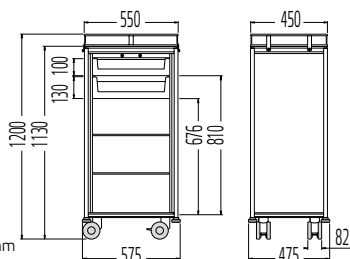

Dimensions in mm
Castors ø 100 mm

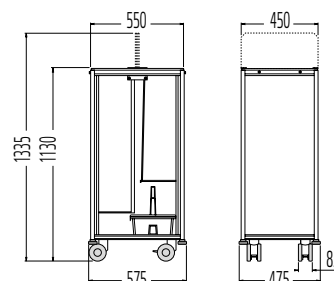

ZP-5 Fresh	Order no.
Standard equipment 575 x 475 x 1200 mm	04.05 350.95-V001
Equipped with 2 nd drawer	04.05 350.95-V002
ZP-5 Clean	Order no.
Standard equipment 575 x 475 x 1130 mm	04.05 360.95-V001

Accessories	Order no.
Additional shelf with fixings	77.22 726.95-0000
Connector	77.44 982.95-0000
Small items box, titanium grey	00.21 837.78-9022
Brochure holder	00.22 289.73-7084

01.06 Linen trolley SW 80

Sorting laundry made easy

> 1-3 modules with bags in 3 colours

> Pre-sorting to save mix-ups

> Robust rubber rings for securing sacks



SW 1/80
Linen bag
in mint

SW 2/80
Linen bags
in red and blue



SW 3/80
Linen bags
in blue, red and apricot

Securely fastened

Robust rubber rings provide simple and secure fastening of the bags.

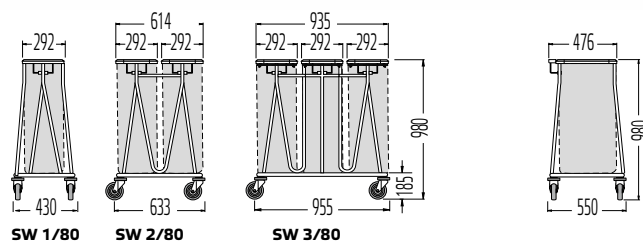

Standard equipment: Sturdy steel-tube design. Chassis with welded grate as support for enhanced stability. Plastic lid with handy opening grip. Bag secured with flexible rubber rings to prevent slipping.

Finish: Plastic powder-coated in titanium grey.

Castors: 4 swivel castors, with plastic deflector rings, rubber tread.

Linen trolley SW 80

SW 1/80, for hanging 1 bag (bag not included)

SW 2/80 for hanging 2 bags (bags not included)

SW 3/80 for hanging 3 bags (bags not included)

Accessories (Bags for first and repeat orders)

1 linen bag, 80 litres, red

1 linen bag, 80 litres, blue

1 linen bag, 80 litres, apricot

1 linen bag, 80 litres, mint

Order no.

04.02 030.75-7084

04.02 035.75-7084

04.02 600.75-7084

00.70 540.00-0000

00.60 935.00-0000

00.61 613.00-0000

00.59 692.00-0000

01.07 Linen trolley SW 145 KX

The agile model for hotels of every size

> *Smart folding mechanism for space-saving storage*

> *Flexible configuration with 2 bag variants*

> *Sturdy steel-tube design with grate attached as support surface*



SW 145 KX
with polyester bag
and hook-and-loop fastener

SW 145 KX
with plastic bag
and holder

It couldn't be easier

The non-wearing
hook-and-loop fastener
secures the polyester bag in
position simply.

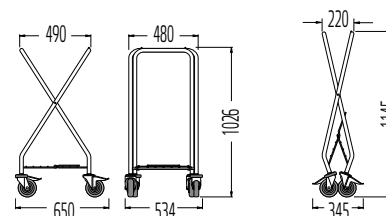

Standard equipment: Sturdy steel-tube design with grate attached as support surface. Hook-and-loop fastener for polyester bag, flat-steel retainer bar for plastic bag. Slip-proof coating on the top bars.

Finish: Plastic powder-coated in titanium grey.

Castors: 4 swivel castors, with plastic deflector rings, including two with brakes, rubber tread.

Linen trolley SW 145 KX	Order no.
Basic fixture with polyester bag and hook-and-loop fastener	04.03 843.95-7084
Basic fixture with plastic bag and holder	04.03 618.95-7084
Accessories	
Holder for plastic bag, incl. fixings	04.03 956.52-0000
Bags for repeat order	
1 polyester bag, 145 litres, grey	77.94 057.00-0000
1 pack of plastic bags, 120 litres, grey (1 pack = 25 units)	00.24 436.00-0000

01.08 Linen trolley SW 240

The XXL model

> Polyester bag with 240 l volume

> All-round hook-and-loop fastening for practically securely the polyester bag

> Sophisticated steel-tube design with sturdy grate as support surface



Practical hook-and-loop fastening

It couldn't be easier:

The non-wearing hook-and-loop fastener secures the polyester bag in position.

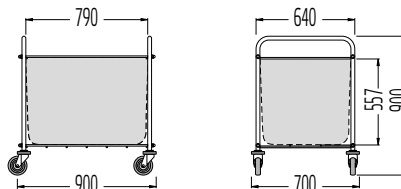

Standard equipment: Steel-tube design with sturdy grate as support surface. Practical all-round hook-and-loop fastening for securing the large polyester bag, optionally with cover.

Finish: Plastic powder-coated in titanium grey.

Castors: 4 swivel castors, with plastic deflector rings and rubber tread.

Linen trolley SW 240	Order no.
As standard with 1 polyester bag, grey	04.02 374.95-7084
As standard with 1 polyester bag with cover, grey	04.02 370.95-7084
Accessories (Bags for repeat order)	
Polyester bag, grey, 240 litres	00.58 562.00-0000
Polyester bag, grey, 240 litres, with cover	00.58 563.00-0000

01.09 Linen trolley SW 3-110

The exquisite design

> 3 finishes

> Extremely nimble even when fully loaded, thanks to the 5th castor equipped as standard

> 3 different types of laundry can be collected separately



SW 3-110
Linen trolley
Illustration shows
special equipment

Finish



Lots of protection

The interior décor is given the best possible protection thanks to the all-round bumper profile and the integrated deflectors.

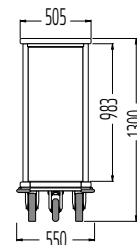
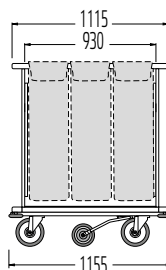

Standard equipment: Steel-tube design, chassis with all-round bumper profile and four integrated rubber deflectors. 3 suspendable polyester bags to be secured with hook-and-loop fastening, 110 litres each, in grey and beige.

Finish: Plastic powder-coated in titanium grey.

Castors: 4 swivel castors with polyamide treads, 5th centre castor, with rubber tread.

Linen trolley SW 3-110	Order no.	
As standard with 5 th castor, 3 polyester bags, 2 x grey, 1 x beige, total volume 330 litres.	Anthracite	04.03 391.95-0008
	Alder	04.03 391.95-0001
	Wenge	04.03 391.95-0003
Accessories (Bags for repeat order)		
Polyester bag, grey, 110 litres		00.22 402.00-0000
Polyester bag, beige, 110 litres		00.36 979.00-0000

01.10 Sprung-base trolley AL

A laundry trolley for smooth service

> *Robust trolley made from aluminium*

> *With automatic height adjustment of the base shelf thanks to a sturdy steel spring*

> *Can be used universally*



SPRUNG-BASE TROLLEY AL

Perfect position

A sturdy steel spring

ensures that the base shelf is always at the ideal height, irrespective of the load.

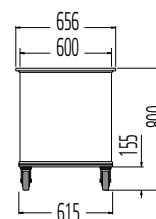
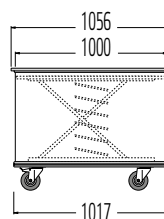

Standard equipment: Robust trolley made from anodised aluminium. The base shelf is raised and lowered automatically depending on the weight of the transported goods. This enables staff to load and unload the trolley comfortably and without straining their back.

Castors: 4 swivel castors, incl. two with brakes.

Sprung-base trolley AL

With adjustable base shelf

Order no.

04.06 216.45-0000

01.11 Shelved laundry container AL

A mobile container for transporting laundry

> *Fold-out container shelves enable easy handling*

> *All-round plastic bumper profile*

> *Plastic roll-down panel as standard*



SHELVED LAUNDRY CONTAINER AL



Transporting clean linen

With roll-down front panel

Mobile container

For transporting dirty laundry and clean linen

in large volumes, saving staff unnecessary trips. The fold-out container shelves can be easily handled, transforming the shelved laundry container AL into a trolley for collecting used laundry in next to no time.

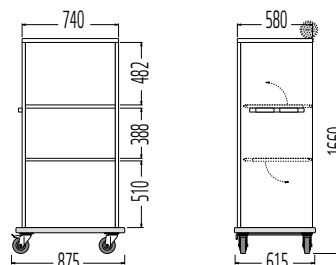

Standard equipment: Sturdy construction made of anodised aluminium. Surrounding plastic bumper profile. Roll-down front panel made of plastic as standard. Two 90° hinged shelves.

Horizontal position: For clean laundry.

Vertical position: For dirty laundry.

Castors: 4 swivel castors, incl. 2 with brake.

Shelved laundry container AL

Incl. roll-down front panel

Order no.

04.05 877.45-0000

01.12 Mobile container RC/S8

A mobile transport container

> *Fully enclosed design*

> *Doors with lockable bar*

> *Optional: adjustable hook-in grate*



RC/S8
mobile container
Illustration shows special equipment

The solution for many different jobs

Ideal for internal transport

High-value goods can also be transported from A to B thanks to the fully enclosed design.

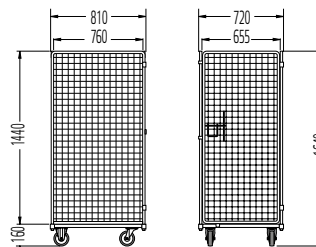

Standard equipment: Fully enclosed container made from square tubing and wire mesh. Doors with lockable bar.

Finish: Plastic powder-coated in titanium grey.

Castors: 2 swivel castors, 2 fixed castors, polyurethane tread.

Mobile container RC/S8	Order no.
Fully enclosed	06.21 639.50-0000
Accessories	
Hook-in grate, straight	28.22 981.50-0000

01.13 Mobile container RC/N2

Nesting container variant

> Effortless collapsing and nesting facilitates storage

> 2-part door, opened separately

> With folding shelf and clothes rail as standard

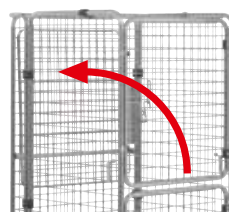

Clothes rail included

For all situations – the clothes rail supplied as standard ensures easy transportation and storage of clothing.

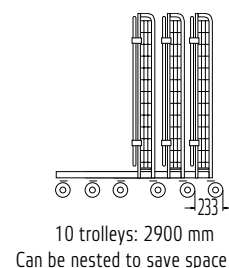
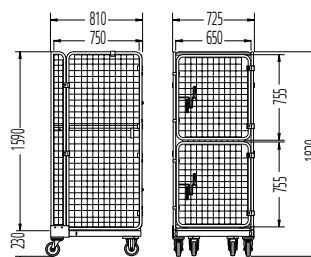

Standard equipment: Container with enclosed sides, can be locked as required. Sturdy construction, made from rectangular tubing, round tubing and wire mesh, plastic hinges. Two-part door, opened separately. With folding shelf and clothes rail as standard.

Finish: High-gloss galvanised, silver.

Castors: 2 swivel castors, 2 fixed castors, polyurethane tread.

Mobile container RC/N2	Order no.
Nesting, with wire shelf and clothes rail as standard	06.17 515.50-V001

01

02

03

04

01.14 Transport baskets TK-R and TK-D

Mobile transport baskets, either open or with a cover

> *Narrow-mesh wire baskets*

> *2 versions*

> *TK-R with bumper, TK-D with lid*



TK-R
transport basket



TK-D
transport basket



Both transport baskets can be stacked to save space.

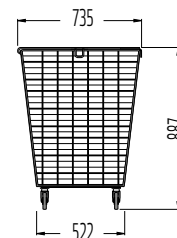
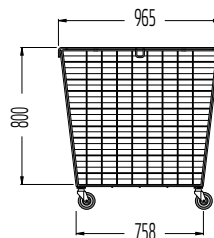
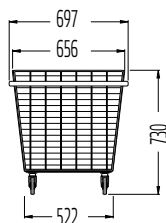
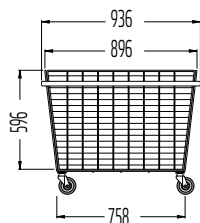

Standard equipment: Narrow-mesh wire basket with white all-round rubber profile as bumper.

Finish: Plastic powder-coated, white.

Castors: 4 swivel castors with plastic deflector rings, rubber tread.

Standard equipment: Tall, narrow-mesh wire basket with lid, can be locked if required. Padlock not included.

Finish: High-gloss galvanised, chrome-plated, silver.

Castors: 4 swivel castors, rubber tread.

Transport basket TK-R	Order no.
With bumper	05.42 710.73-9010

Transport basket TK-D	Order no.
With lid	05.41 810.50-0000

01.15 Room change trolley RCW

A professional solution for changing rooms

> *Quick and easy*

> *With clothes rail and 2 wire shelves as standard*

> *Matching clothes hangers optional*



RCW
room change trolley

Suspended coat rail

For protecting items during transport: Provides a professional way for guests to change rooms or living quarters quickly and easily.

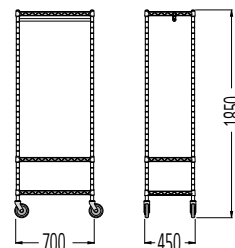

Standard equipment: Uprights with end caps. Plastic clamping bushes for mounting the wire shelves at 50-mm intervals. Robust wire shelves, each with 4 enclosed bushes.

Finish: High-gloss, chrome-plated uprights and clothes rail, wire shelves with plastic powder coating, white.

Castors: 4 plastic swivel castors, rubber tread, with 2 brakes.

Room change trolley RCW	Order no.
With clothes rail and 2 wire shelves	04.30 011.10-0000
Accessories	
Clothes hanger made from wire, with high-gloss chrome plating	00.79 265.10-0000

01.16 Clothes stand GR

A pared-down form with unsurpassed functioning

> *Can be nested to save space*

> *Easy to move on castors, brakes optionally available*

> *With practical hat rack*



GR
nesting clothes stands

GR
clothes stand
Illustration shows special equipment

Right at the top

Practical hat rack:
perfect storage, quickly
available to hand again.

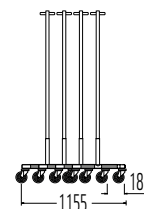
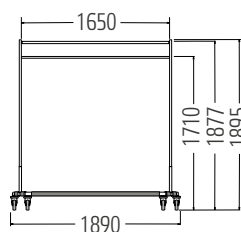

Standard equipment: Elegant steel-tube design with coat rail and practical hat rack. Conical chassis, can be nested to save space.

Finish: Chassis with plastic powder coating in titanium grey, other parts high-gloss chrome-plated.

Castors: 4 swivel castors with rubber treads, supplied with plastic deflector rings as standard.

Clothes stand GR	Order no.
With hat rack	04.02 713.95-7084
With hat rack and 2 brakes	04.02 713.95-0001
Accessories	
Clothes hanger made from wire, with high-gloss chrome plating	00.79 265.10-0000

01.17 Case stand KS 600

Somewhere for every item of luggage

> *An indispensable feature of every guest room*

> *Rear bar to prevent slipping*

> *Folding mechanism for space-saving storage*

01

02

03

04



KS 600
case stand, folded



KS 600
high-gloss, chrome-plated



KS 600
hammer finish



KS 600
flash gold-plated

Protects the interior décor in your hotel

The **high bar** and the extension of the rear feet ensure the necessary distance is kept from the wall to avoid damage.

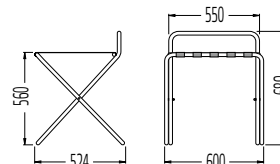

Standard equipment: Easy-to-handle tube frame with bar at back to prevent slipping. Folding mechanism for space-saving storage. Heavy-duty black belts prevent damage to cases.

Finishes: Choice of high-gloss chrome-plated, hammer finish or flash gold-plated.

Case stand KS 600	Order no.
KS 600 high-gloss, chrome-plated	04.01 922.10-0000
KS 600 flash gold-plated	04.01 922.58-0000
KS 600 hammer finish	04.01 922.73-7087

02 Product overview

02.01 – 02.04 Luggage collection trolleys



01 GS-TREND



02 GS-LOBBY



03 GS-GROUP



04 GS-COMPACT

02.05 – 02.08 Luggage transport trolleys



05 AERA 300 L



06 VOYAGER 3000



07 TRAVEL 300



08 EASY 400

02.09 – 02.10 Guidance systems



09 PART FLEX 2000



10 PART LINE 2000

02 Front Office

01

02

03

04



02.01 Premium GS-Trend

The extravagant luggage collection trolley

> *An eye-catcher at check-in*

> *Very nimble, optional locking brake*

> *Integrated coat rail*



GS-TREND
Plastic powder-coated
metallic black
Illustration shows special equipment

Design pend.

02.01 Premium GS-Trend

Create an elegant impression from the very start

■ The new trend. Innovation and quality packaged in an elegant design: the GS-Trend.



GS-TREND
Stainless steel
Illustration shows
special equipment



Design pend.

Carpet finishes



Optional locking brake

Securely positioned: Even when the GS-Trend is loaded with lots of luggage, the brake holds it in place on uneven flooring.

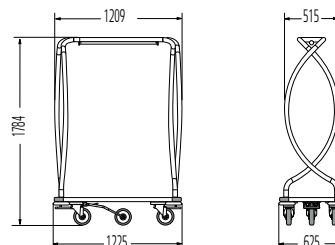

Standard equipment: Round-tube design with coat rail. Sturdy platform with all-round bumper and deflectors, heavy-duty, stain-resistant carpet in anthracite.

Finish: Electro-polished stainless steel.

Castors: 4 swivel castors, quiet rubber tread, 5th central castor for safe manoeuvring.

Luggage collection trolley GS-Trend	Order no.
Electro-polished stainless steel, carpet in anthracite	05.59 778.31-V001
Steel, with plastic powder coating, metallic black, carpet in anthracite	05.59 778.75-V001
Electro-polished stainless steel, carpet in anthracite, with brake	05.59 778.31-V002
Steel, with plastic powder coating, metallic black, carpet in anthracite, with brake	05.59 778.75-V002

02.02 GS-Lobby

The elegant luggage collection trolley

> Available in high-quality finishes

> Attractive, durable carpet lining

> Optional with locking brake

Carpet finishes



GS-LOBBY
Steel, with plastic powder coating,
with brake



GS-LOBBY
Electro-polished
stainless steel, with brake



*Prevents the trolley
accidentally rolling
away*

Optional locking brake
An ideal addition to make the
GS-Lobby secure on inclines.

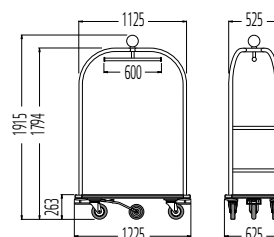

Standard equipment: Round-tube design with elegant 'crown' and coat rail. Sturdy platform with all-round bumper and deflectors, heavy-duty, stain-resistant carpet in anthracite.

Finish: Electro-polished stainless steel.

Castors: 4 swivel castors, quiet rubber tread, 5th central castor for safe manoeuvring.

Luggage collection trolley GS-Lobby	Order no.
Electro-polished stainless steel, carpet in anthracite	05.65428.31-V002
Steel, with plastic powder coating, carpet in anthracite	05.65428.75-V002
Electro-polished stainless steel, carpet in anthracite, with brake	05.65428.31-V001
Steel, with plastic powder coating, carpet in anthracite, with brake	05.65428.75-V001

02.03 GS-Group

The luggage collection trolley for group luggage

> *With generous, stable luggage storage*

> *Plastic profiles on the sides to protect the interior décor*

> *Coat rail comes as standard and can be removed as required*



GS-GROUP
luggage collection trolley

Coat rail as standard

Can be removed if necessary: a thoroughly practical detail, it can be flexibly adjusted to match the type and amount of luggage.

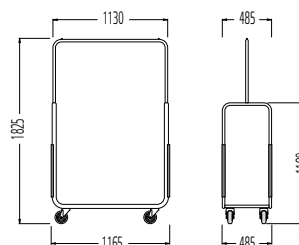

Standard equipment: Round-tube design with robust storage area for cases and bags. Plastic profiles mounted at the side on the upright struts to protect the interior.

Finish: Steel, high-gloss chrome-plated

Castors: 2 swivel castors, 2 fixed castors, with quiet rubber tread.

Luggage collection trolley GS-Group

Order no.

High-gloss chrome plated

04.02 148.10-0000

02.04 GS Compact

The practical luggage collection trolley

> Provides and saves valuable space with its fold-out loading areas

> Available with a choice of short or long loading areas

> Pneumatic tyres (250 mm) for smooth running



Stable even when fully laden

As practical as it gets.

Provides generous load capacity while saving valuable space with its fold-out loading areas in 2 lengths.

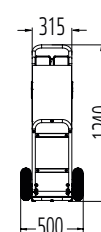
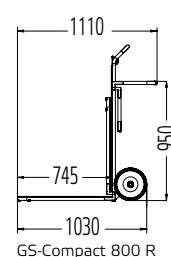
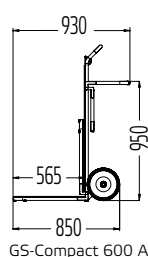

Standard equipment: Round-tube design. Platform can be unfolded for use and folded back up if necessary for space-saving storage. Loading area covered with tough, non-slip carpet.

Finish: Stainless steel.

Castors: 2 pneumatic tyres for smooth running, black tread.

Luggage collection trolley GS-Compact	Order no.
GS-Compact 600 R, carpet in red	05.26 782.31-V003
GS-Compact 600 A, carpet in anthracite	05.26 782.31-V002
GS-Compact 800 R, carpet in red	05.23 731.31-V003
GS-Compact 800 A, carpet in anthracite	05.23 731.31-V002

02.05 Aera 300 L

The stylish luggage transport trolley

> *Impresses with its clear geometry*

> *Large deflectors protect luggage – the all-round bumper rail protects the interior décor*

> *Large, high-quality castors guarantee easy handling*



AERA 300 L
luggage transport trolley

Design pend.

Large, protective deflectors

Luggage remains undamaged.
A detailed solution which helps the Aera 300 L to impress.

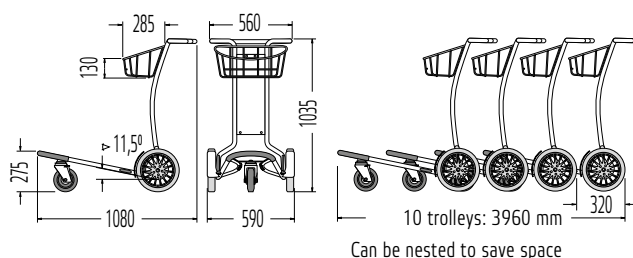

Standard equipment: Round-tube design. All-round bumper rail on the large loading area. Generous powder-coated basket. Can be nested to save space.

Finish: High-gloss, galvanised, chrome-plated finish with additional transparent coating.

Castors: 2 fixed castors, 1 swivel castor.



Special feature included extra: The handle of the Aera 300 L is treated with an anti-bacterial coating, ensuring hygienic conditions in the hotel environment.

Luggage transport trolley Aera 300 L	Order no.
Galvanised chrome-plated steel	05.60 795.52-0000

01

02

03

04

02.06 Voyager 3000

Luggage transport trolleys with an impressive design

> *Extremely easy operation thanks to automatic brake bar*

> *Antibacterial, ergonomic handle with printed operating instructions*

> *All-round bumper rail to protect the interior décor*

Pat. pend.

VOYAGER 3000
luggage transport trolley



Zero-maintenance brake bar

Functionality
and safety for your guests
in one system.



Pat. pend.

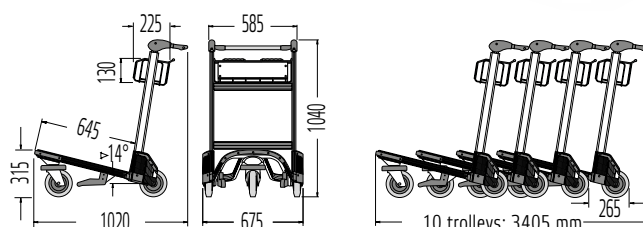

Can be nested to save space

Standard equipment: Aluminium construction.

All-round bumper rail on the large loading area. Practical basket for hand luggage or travel paraphernalia. Can be nested to save space.

Finish: Anodised aluminium. Basket in electro-polished stainless steel.

Castors: 2 fixed castors, 1 swivel castor, rubber treads.



Special feature included extra: The handle of the Voyager 3000 is treated with an antibacterial coating, ensuring hygienic conditions in the hotel environment.

Luggage transport trolley Voyager 3000	Order no.
Voyager 3000, anodised aluminium, with brake	05.48 251.95-0000

02.07 Travel 300

Luggage transport trolley – simple and convenient

> *Antibacterial, ergonomic handle with side caps*

> *Can be nested to save space*

> *Plastic profiles prevent damage to the interior décor*



TRAVEL 300
luggage transport trolley

Pat. pend.

A stylish space-saver

Wanzl luggage transport trolleys

are stylish space-savers for use anywhere. Very nimble and capable of nesting extremely compactly, they allow even large numbers to be used in hotels of all kinds – a benefit that your guests will appreciate, too.

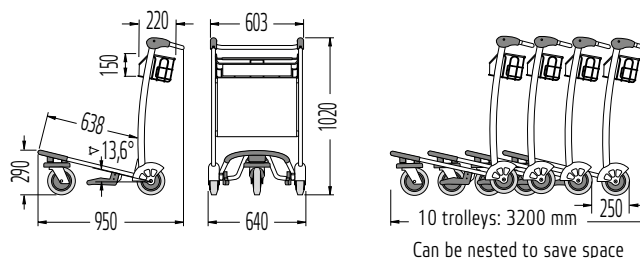

Can be nested to save space

Standard equipment: Steel-tube design with sturdy luggage support. Self-adjusting, zero-maintenance brake. All-round bumper rail on the loading area. Practical basket for hand luggage or travel paraphernalia. Can be nested to save space.

Finish: High-gloss, galvanised, chrome-plated finish with additional transparent coating.

Castors: 2 fixed castors, 1 swivel castor, rubber treads.



Special feature included extra: The handle of the Travel 300 is treated with an antibacterial coating, ensuring hygienic conditions in the hotel environment.

Luggage transport trolley Travel 300	Order no.
Travel 300, galvanised chrome-plated steel, with brake	05.44 296.52-V008

01

02

03

04

02.08 Easy 400

Small but high-quality luggage transport trolley

> *Compact design*

> *Plastic profiles and castor covers prevent damage to the interior décor*

> *High-quality swivel castors with quiet rubber tread*



EASY 400
luggage transport trolley

Plastic parts on the castor as standard

In addition to the all-round bumper rail. These protect the interior décor in your hotel from damage.

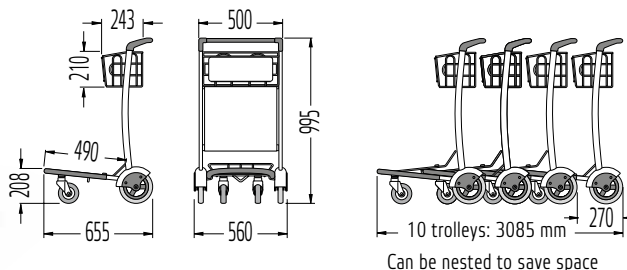

Standard equipment: Steel-tube design with sturdy luggage support. All-round bumper rail on the loading area. Practical basket for hand luggage or travel paraphernalia. Can be nested to save space.

Finish: High-gloss, galvanised, chrome-plated finish with additional transparent coating.

Castors: 2 fixed castors, 2 swivel castors, rubber treads.



Special feature included extra: The handle of the Easy 400 is treated with an anti-bacterial coating, ensuring hygienic conditions in the hotel environment.

Luggage transport trolley Easy 400	Order no.
Easy 400, galvanised chrome-plated steel	05.13 100.52-7016

02.09 Part Flex 2000

Flexible guidance system

> A mobile and effective way to section off areas

> Uprights made of steel tubing with integrated reel mechanism for pull-out bands

> Triple docking facility



PART FLEX 2000
guidance system

Extremely easy to use.

WALL CLIP
made from high-grade steel

Barriers in up to 4 directions

Very flexible and effective guidance system, can be used to separate areas and direct people.



Printed pull-out band

Your hotel logo can be printed according to requirements. Fully in keeping with your universal corporate design.



On request.

Standard equipment: Uprights made from steel tubing with integrated reel mechanism and triple docking facility. Pull-out bands in 3 colours, 2000 mm long. Base plate with slip-proof plastic profile, cover made from black plastic.

Finish: Uprights with high-gloss chrome plating

Dimensions: Upright height 940 mm, base plate Ø 340 mm.

Part Flex 2000	Order no.
Upright with pull-out band, red	23.75 100.10-0000
Upright with pull-out band, dark blue	23.75 101.10-0000
Upright with pull-out band, grey	23.75 102.10-0000
Accessories	
Wall clip	23.92 892.09-0000

02.10 Part Line 2000

One of the finest examples of guidance systems

> *Smooth elegance for every occasion*

> *Subtle separation of lobbies, foyers and meeting rooms*

> *With practical accessories: placard holder*



MODEL L
in chrome and brass

MODEL C
in chrome and brass

MODEL P
in stainless steel

02.10 Part Line 2000

Order part

01

02

03

04



MODEL L
in chrome with poster holder
Twisted polypropylene rope in red

Part Line 2000		Supplied unassembled	Order no.	Order no.	Order no.
Uprights					
Material			Chrome	Brass	Stainless steel
		Model L with conical head, height 950 mm, base plate ø 320 mm	04.07 122.10-0001	04.07 128.06-0000	-
		Model C with round head, height 1010 mm, base plate ø 320 mm	04.07 120.10-0001	04.07 127.06-0000	-
		Model P with conical head, height 960 mm, base plate ø 350 mm	-	-	04.07 130.09-0000
Wall fixing bracket					
		Wall fixing bracket	04.07 233.10-0000	04.07 233.06-0000	-
Rope – velvet, 2 m					
End pieces	Rope colour		End piece, chrome	End piece, brass	End piece, stainless steel
		Red	77.38 646.00-0001	77.38 647.00-0001	-
		Black	77.38 646.00-0002	77.38 647.00-0002	-
Rope – twisted polypropylene, 2 m					
End pieces	Rope colour		End piece, chrome	End piece, brass	End piece, stainless steel
		Red	77.38 645.00-0001	77.38 648.00-0001	77.38 649.00-0001
		Black	77.38 645.00-0002	77.38 648.00-0002	77.38 649.00-0002
Accessories					
Poster holder for uprights (designs L + P)			Chrome	Brass	-
		DIN A4 portrait	04.07 124.00-0000	04.07 126.00-0000	-
		DIN A4 landscape	04.07 125.00-0000	04.07 131.00-0000	-

03 Product overview

03.01 – 03.02 Premium minibar filling trolleys



01 MBW-SMART



02 MBW-SECURE

03.03 – 03.06 Service and serving trolleys

03 BANQUET SERVICE
TROLLEYS BS

04 RSVC-COMFORT



05 SERVING TROLLEY EG 200 + EG 300



06 SERVING TROLLEY EU 200 + EU 300

03.07 – 03.11 Tray and plate trolleys



07 TBL 20



08 TB 16



09 TW-CLASSIC



10 TW-POLY

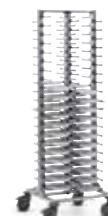

11 TW-SOLO

03.12 Bottle trolley

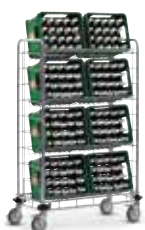

12 FW-8

03 Food + Beverages

01

02

03

04



03.01 Premium MBW-Smart

Minibar filling trolley – with 2 shelves

> *Locking roll-down panel*

> *Insertable shelves with wire bar – railing to prevent slipping*

> *5th castor allows it to turn on the spot*



MBW-SMART
Anthracite finish
Illustration shows special equipment

Design pend.

03.01 Premium MBW-Smart

01

02

03

04

- A reliable partner for minibar service
 - with clearly structured divisions for efficient filling with bottles and small items.

Security as standard

Locking roll-down panels for all MBW-Smart models.



Protective feature

Integrated deflectors made of rubber and all-round bumper profile protects the interior décor of your hotel.



Standard equipment: Steel-tube design, 2 fixed and 2 height-adjustable shelves. Chassis with all-round bumper profile and integrated rubber deflectors. Front side with lockable roll-down panel.

Finish: Plastic powder-coated in titanium grey.

Castors, MBW-Smart-7: 2 swivel castors, 2 fixed castors, with polyamide treads.

MBW-Smart-9/-11: 4 swivel castors with polyamide tread, 5th central castor with rubber tread.

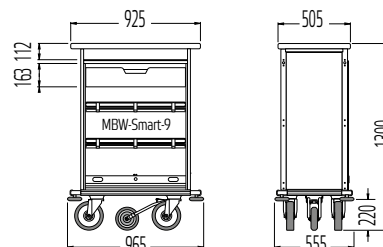

Other dimensions for MBW-Smart as on fold-out page 13.

Minibar filling trolley models		MBW-Smart-7	MBW-Smart-9	MBW-Smart-11
Dimensions		765 x 527 x 1300	925 x 527 x 1300	1115 x 527 x 1300
		Order no.	Order no.	Order no.
MBW-Smart	anthracite, alder or wenge finish	04.01 250.95-V	04.01 251.95-V	04.01 252.95-V

Special equipment				
Drawer made from sheet steel, with plastic powder coating, titanium grey		☑	☑	☑
Shelf, shortened, with wire bar to prevent slipping	anthracite, alder or wenge finish	☑	☑	☑
Lockable lid	anthracite, alder or wenge finish	☑	☑	☑
Castors with rubber tread		☑	☑	☑
Accessories				
Wooden box for small items, pearl light grey varnished		00.21 837.78-9022	00.21 837.78-9022	00.21 837.78-9022
Wooden box for small items, transparent varnished		00.60 694.78-0000	00.60 694.78-0000	00.60 694.78-0000
Brochure holder, metal, titanium grey		00.22 289.73-7084	00.22 289.73-7084	00.22 289.73-7084
Top box, metal, plastic powder-coated in titanium grey		04.03 504.73-7084	04.03 504.73-7084	04.03 504.73-7084
Adjustment option for top box		1	1	2
Drawer compartment divider		77.76 090.73-7084	77.76 090.73-7084	77.76 090.73-7084

03.02 Premium MBW-Secure

Minibar filling trolley – with 3 drawers

> *With lockable plastic roll-down panel as standard*

> *5th castor allows it to turn on the spot*

> *Transports bottles upright up to a height of 31 cm*



MBW-SECURE
Anthracite finish
Illustration shows special equipment

Design pend.

03.02 Premium MBW-Secure

01

02

03

04

■ For reliable minibar service. Improved design incorporating new drawer division, optimised recessed handles and an effective bumper.

Upright transportation of bottles

A highlight for the minibar service is the upright transportation of 0.7-litre bottles.



Practical compartment dividers

Create order when filling minibars and prevent bottles from falling over during transport.



Standard equipment: Steel-tube design, 3 stable drawers, each with 2 compartment dividers, can be pulled out individually, with built-in lock. Chassis with all-round bumper profile and integrated rubber deflectors. Front side with lockable roll-down panel.

Finish: Plastic powder-coated in titanium grey.

Castors, MBW-Secure-7: 2 swivel castors, 2 fixed castors, with polyamide treads.

MBW-Secure-9/-11: 4 swivel castors with polyamide tread, 5th central castor with rubber tread.

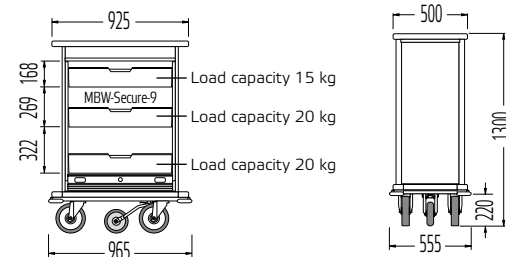

Other dimensions for MBW-Secure as on fold-out page 13.

Minibar filling trolley models		MBW-Secure-7	MBW-Secure-9	MBW-Secure-11
Dimensions		765 x 527 x 1300	925 x 527 x 1300	1115 x 527 x 1300
		Order no.	Order no.	Order no.
MBW-Secure	anthracite, alder or wenge finish	04.03 140.95-V	04.03 150.95-V	04.03 160.95-V

Special equipment				
Lockable lid	anthracite, alder or wenge finish	☑	☑	☑
Castors with rubber tread		☑	☑	☑
Accessories				
Wooden box for small items, pearl light grey varnished		00.21 837.78-9022	00.21 837.78-9022	00.21 837.78-9022
Wooden box for small items, transparent varnished		00.60 694.78-0000	00.60 694.78-0000	00.60 694.78-0000
Brochure holder, metal, titanium grey		00.22 289.73-7084	00.22 289.73-7084	00.22 289.73-7084
Top box, metal, plastic powder-coated in titanium grey		04.03 504.73-7084	04.03 504.73-7084	04.03 504.73-7084
Adjustment option for top box		1	1	2
Drawer compartment divider		77.76 090.73-7084	77.76 090.73-7084	77.76 090.73-7084

03.03 Premium-BS

Banquet service trolley – always a good appearance

> 3 finishes

> 5th castor allows it to turn on the spot

> Additional insertable shelves



BS-11
Anthracite finish
with accessories

Standard equipment: Steel-tube design, 2 fixed and 2 height-adjustable shelves. Chassis with all-round bumper profile and integrated rubber deflectors.

Finish: Plastic powder-coated in titanium grey.

Castors, BS-7: 2 swivel castors, 2 fixed castors, with polyamide treads.

BS-9/BS-11: 4 swivel castors with polyamide tread, 5th central castor with rubber tread.

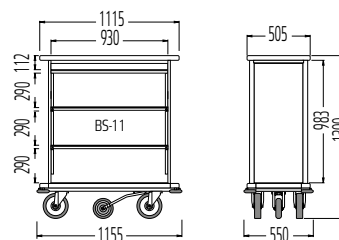

Other dimensions for Premium-BS as on fold-out page 13.

Banquet service trolley		BS-7	BS-9	BS-11
Dimensions		765 x 527 x 1300	925 x 527 x 1300	1115 x 527 x 1300
		Order no.	Order no.	Order no.
Premium-BS	anthracite, alder or wenge finish	04.01 583.95-V	04.01 584.95-V	04.01 585.95-V
Special equipment				
Additional shelf	anthracite, alder or wenge finish	☐	☐	☐
Lockable lid	anthracite, alder or wenge finish	☐	☐	☐
Castors with rubber tread		60.59 891.00-0000	60.59 778.00-0000	

03.04 RSVC-Comfort

The room-service table

> With hinged side parts

> Can be nested to save space

> Available with optional hot box



RSVC-COMFORT
room-service table

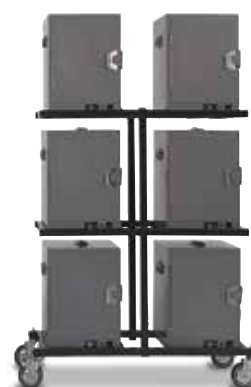

SHELVING UNIT
Mobile, for storing up to
6 hot boxes



RSVC-Comfort, collapsed



RSVC-Comfort with hot box

Electric hot box and standard hot box

With 3 shelves, both hot box models are ideal for ensuring meals stay hot on their way to guest rooms.



HOT BOX
standard

HOT BOX
electric

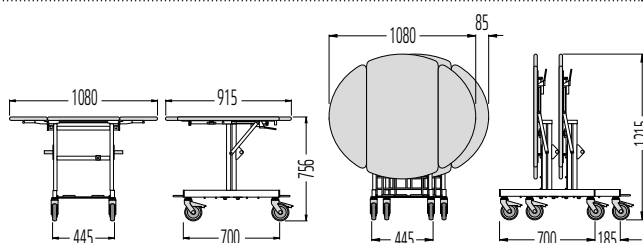

Can be nested to save space

Standard equipment: Steel-tube design with oval table top in wood finish with tough, sealed edge and fold-down side parts. Fold-out chrome-plated rack for the hot box. The table tops can be locked in a vertical position for storage and transport and the RSVC-Comfort can be nested to save space.

Finish: Plastic powder coating in slate grey, RAL 9005.

Castors: 4 swivel castors, incl. 2 with brake, rubber tread.

Room service table RSVC-Comfort	Order no.
With hinged side parts	05.23 844.95-0000
Accessories	
Dimensions for 1 hot box (mm): W 380 x D 400 x H 510	
Electric hot box, with 3 shelves, hammer-effect silver finish	00.59 790.09-0000
Electric hot box, with 3 shelves, hammer-effect black finish	00.59 790.09-0001
Standard hot box, with 3 shelves, hammer-effect silver finish	00.59 903.09-0000
Shelf unit for 6 hot boxes, mobile	
Dimensions (mm) width 1070 x depth 490 x height 1900	04.04 634.09-0000

03.05 EG 200 and EG 300

The classic serving trolley

- > Available with 2 or 3 shelves
- > High edges all around for safe transport
- > Hygienic from stainless steel



EG 200
serving trolley



EG 300
serving trolley

Brake as standard

Safety feature: Two high-quality swivel castors are equipped with brakes as standard. (EG 200 and EG 300)

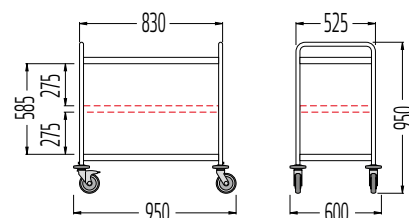

Standard equipment: Round-tube design, available with 2 or 3 shelves.

Finish: Round tubing and shelves made from stainless steel.

Castors: 4 swivel castors with plastic deflector rings, 2 with brake. Rubber tread.

Serving trolley EG	Order no.
EG 200 with 2 shelves	04.04 401.09-0000
EG 300 with 3 shelves	04.04 400.09-0000

03.06 EU 200 and EU 300

Flexible, nimble serving trolley

> Available with 2 or 3 wire shelves and wooden board bases

> High wire edging

> Safe transport

01

02

03

04



EU 200
serving trolley



EU 300
serving trolley

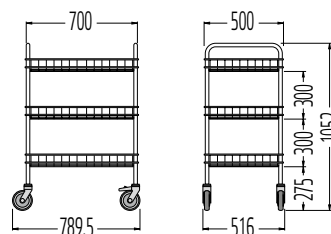
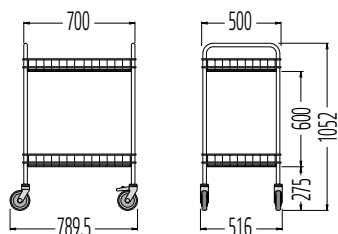

Standard equipment: Round-tube handle. 2 wire shelves with wooden board bases in birch finish. High edges made from wire.
Finish: Handles and wire shelves high-gloss chrome-plated.
Castors: 4 swivel castors, 2 with brakes, rubber tread.

Standard equipment: Round-tube handle. 3 wire shelves with wooden board bases in birch finish. High edges made from wire.
Finish: Handles and wire shelves high-gloss chrome-plated.
Castors: 4 swivel castors, 2 with brakes, rubber tread.

Serving trolley EU 200	Order no.
With 2 shelves	04.08 137.10-0000

Serving trolley EU 300	Order no.
With 3 shelves	04.02 487.10-0000

03.07 TBL 20

An elegant, functional tray trolley

> Holds 20 trays in 2 rows

> Sturdy, melamine resin-laminated panels in birch finish

> Brakes as standard



TBL 20
tray trolley

Indispensable in the catering business

The mobile tray trolley:

For efficient and time-saving service processes. Functional equipment and high-quality visual appearance form an exemplary unit.

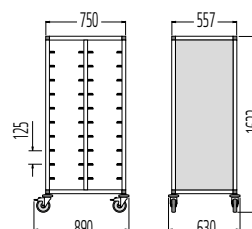

Standard equipment: Frame made of special-purpose anodised light-alloy profiles. Two separate compartments, enclosed on all sides by melamine resin-laminated panels in birch finish. 10 tray supports on each side, made of high-gloss, chrome-plated wire.

Castors: 4 swivel castors with deflector rings, 2 with brakes, rubber tread.

Tray trolley TBL 20

For holding up to 20 trays

Plastic tray in light mocha

Order no.

04.05 651.95-0000

04.05 086.78-0000

03.08 TB 16

A functional, high-quality tray trolley

> Holds 16 trays in 2 rows

> Side panels in wood finish

> Brakes as standard



TB 16
tray trolley

Optimum handling

Safely stowed:
Wide wire supports for easy insertion of trays.

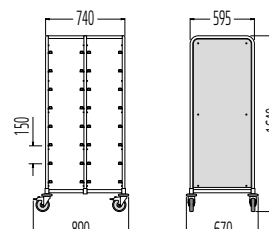

Standard equipment: Round-tube and wire design with side panels in wood finish. Supports made of wire to safely load trays.

Finish: High-gloss chrome plated.

Castors: 4 swivel castors with deflector rings, 2 with brakes. Rubber tread.

Tray trolley TB 16

For holding up to 16 trays

Plastic tray in light mocha

Order no.

04.04 973.95-0000

04.05 086.78-0000

01

02

03

04

03.09 TW-Classic

A classic and cost-effective plate trolley

> *Adjustable wire dividers*

> *Wire plate shelves and dividers*

> *Available with optional cutlery tray*



Cutlery tray
optional

TW-Classic
plate trolley

Adjustable wire dividers

Varying plate sizes are ideally held by the adjustable wire dividers.

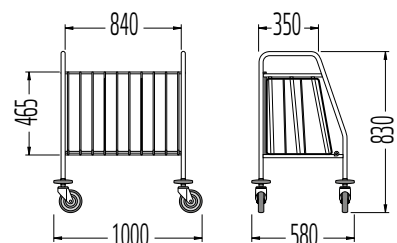

Standard equipment: Round-tube construction with wire plate holders and dividers.

Finish: Electro-polished stainless steel tube frame, high-gloss finish.

Castors: 4 swivel castors with plastic deflector rings.

Plate trolley TW-Classic	Order no.
With 2 wire dividers Capacity: up to 150 large dinner plates, max. Ø 28 cm	04.13 159.31-0000
Accessories	
Cutlery tray	00.61 726.07-0000

03.10 TW-Poly

Sturdy plastic plate trolley

> *High loading capacity*

> *Adjustable dividers for adapting to different plate sizes*

> *With 4 dividers and protective cover as standard*

01

02

03

04



TW-Poly
plate trolley

Protective cover as standard

Protected from dirt when not in use thanks to easy-clean plastic.

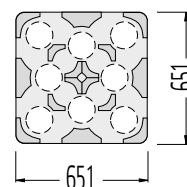
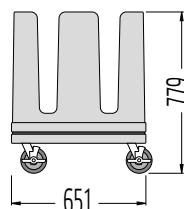

Standard equipment: Polymer housing with a polyurethane core. Adjustable dividers for adapting to different plate sizes. Plastic protective cover.
Castors: 4 swivel castors, incl. 2 with brake.

Plate trolley TW-Poly	Order no.
With 4 dividers, 1 central insert and 1 protective cover Capacity: up to 400 saucers / side plates, Ø 15-18 cm up to 200 large dinner plates, Ø 28-29 cm	05.23 957.07-0000
Accessories	
Additional compartment divider	00.60 920.07-0000

03.11 TW-Solo

A plate trolley for fast serving

> *Simultaneous distribution of 80 portions of food*

> *Attractive plate clips keep the dishes securely in place and prevent breakage*

> *Extreme space-saving storage*

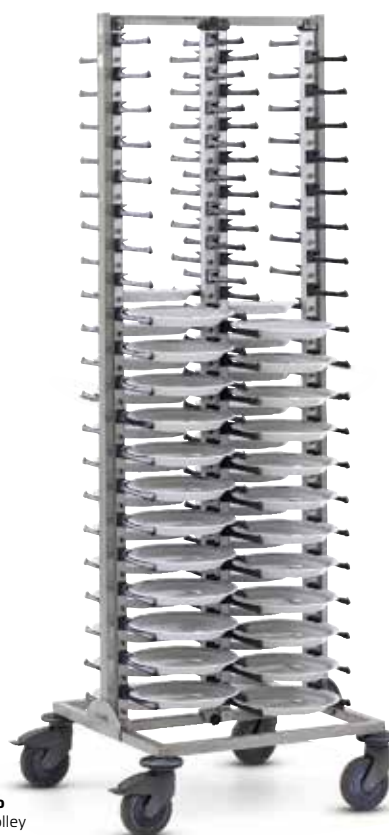

TW-Solo
plate trolley

Optional protective cover

To protect against drying out
and to keep prepared food hot.
Also to protect from dirt when not
in use.

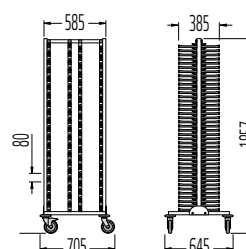

Standard equipment: Torsionally rigid, stainless steel frame with plastic-coated plate struts and patented plate clips for adapting to different plate sizes.

Finish: Stainless steel.

Castors: 4 swivel castors, 2 with brakes, rubber tread.

Single plate trolley TW-Solo

For 80 plates, max. Ø 30 cm
and occupying just 0.5 sq. m

Order no.

05.24 183.09-0000

Accessories

Plastic protective cover

00.61 146.07-0000

03.12 FW-8 and FW-16

The mobile, space-saving bottle trolley

> *Sturdy round-tube steel frame*

> *Stores and transports 8 or 16 crates*

> *With 2 brakes as standard*



FW-8
bottle trolley

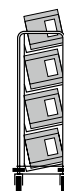

FW-8 - For
8 drinks crates



FW-16 - For
16 drinks crates

Mobile storage

With 2 brakes as standard:

Prevents the trolley rolling away unintentionally, thus securing up to 16 crates in position.

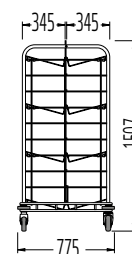
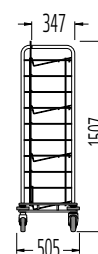
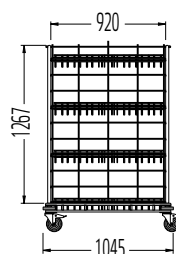

Standard equipment: Round-tube steel frame. Wire mesh shelves, side grates and chassis.

Finish: High-gloss, galvanised, chrome-plated

Castors: 4 swivel castors with plastic deflector rings, 2 with brake, rubber tread.

Bottle trolley	Order no.
FW 8 - single-sided	05.84 653.50-0000
FW 16 - double-sided	05.84 654.50-0000

01

02

03

04

04 Product overview

04.01 Service shelves



01 HIGH RACK + HIGH RACK, MOBILE

04.02 – 04.03 Transport trolleys



02 T2

03 W 71 E

04.04 Adjustment options for sports equipment



04 SKI / SNOWBOARD STANDS

04 Storage + Shelving

01

02

03

04



04.01 High rack

Fixed and movable service shelf

> Numerous different base and expansion elements

> Shelves also available in plastic powder coating, white

> Always delivered unassembled – variable installation of the shelves



HIGH RACK
fixed, corner combination
5 shelves, high-gloss chrome-plated
(Example structure)



SHELF-CONNECTOR
Accessory



HIGH RACK
movable,
4 shelves with plastic powder coating,
white

HIGH RACK
fixed,
5 shelves with plastic powder coating,
white

04.01 High rack

For even better organisation

■ One of the most modern systems for organisation and transport, with numerous different base and expansion elements – fixed and movable – as required.

Variable installation of the shelves

With plastic clamping bushes in the 50 mm grate, the shelves can be flexibly adjusted to the desired height.

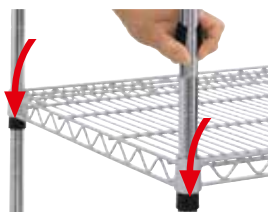

High rack, movable

With high-quality swivel castors, 2 with brakes – guarantee stability and mobility as required.



Standard equipment:

High-gloss, chrome-plated uprights with top end caps and plastic feet or 4 swivel castors, 2 with brakes. Wire shelves in high-gloss chrome-plating or plastic powder coating, white. Plastic clamping bushes for assembly of the wire shelves, with a mesh width of 165 x 20 mm.

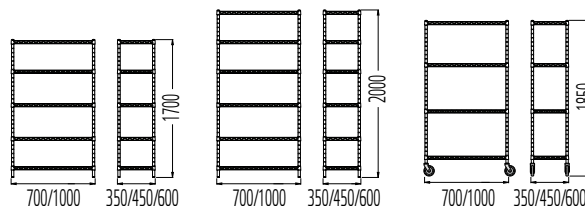

High rack, fixed		Order no.	Order no.	Order no.
	Widths (mm)	Depth 350	Depth 450	Depth 600
Height 1700 with 5 shelves				
Uprights and shelves:	700 mm	04.30 000.10-0000	04.30 001.10-0000	04.30 002.10-0000
High-gloss chrome plated	1000 mm	04.30 003.10-0000	04.30 004.10-0000	04.30 005.10-0000
Uprights: High-gloss chrome plated	700 mm	04.30 000.95-9010	04.30 001.95-9010	04.30 002.95-9010
Shelves: Plastic powder-coated, white	1000 mm	04.30 003.95-9010	04.30 004.95-9010	04.30 005.95-9010
Height 2000 with 6 shelves				
Uprights and shelves:	700 mm	-	04.30 006.10-0000	04.30 007.10-0000
High-gloss chrome plated	1000 mm	-	04.30 008.10-0000	04.30 009.10-0000
Uprights: High-gloss chrome plated	700 mm	-	04.30 006.95-9010	04.30 007.95-9010
Shelves: Plastic powder-coated, white	1000 mm	-	04.30 008.95-9010	04.30 009.95-9010
Accessories				
Shelf-connector		04.30 020.00-0000		
High rack, movable		Order no.	Order no.	
	Widths (mm)	Depth 450	Depth 600	
Height 1850 with 4 shelves				
Uprights and shelves:	700 mm	04.03 000.10-0000	04.03 011.10-0000	
High-gloss chrome plated	1000 mm	04.02 826.10-0000	04.03 010.10-0000	
Uprights: High-gloss chrome plated	700 mm	04.03 000.95-9010	04.03 011.95-9010	
Shelves: Plastic powder-coated, white	1000 mm	04.02 826.95-9010	04.03 010.95-9010	

04.02 T2

W 71 E

The easy-to-use transport trolley for all occasions

> *Wooden platform*

> *Wire mesh platform*

> *2 fixed castors at front, 2 swivel castors at rear*

> *4 swivel castors*

> *Solid design*

> *Can be collapsed by hand*

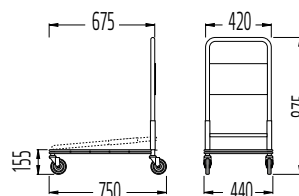
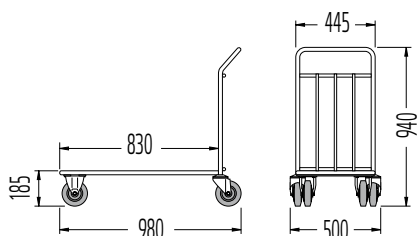

Standard equipment: Round-tube chassis and pushing handle, wooden platform with waterproof sealing.

Finish: Plastic powder-coated, anthracite grey.

Castors: 2 fixed castors at front, 2 swivel castors at rear, rubber tread.

Standard equipment: Wire mesh platform, round-tube pushing handle. Easy-to-use folding mechanism, self-locking.

Finish: High-gloss, galvanised, chrome-plated.

Castors: 4 swivel castors, rubber tread.

Transport trolley T2

Order no.

With wooden platform

05.03 910.76-V010

Transport trolley W 71 E

Order no.

With wire platform, collapsible

05.21 996.50-V004

04.03 Ski / snowboard stands

Adjustment options for sports equipment

> *Movable round-frame construction with additional corrosion protection*

> *Support surface on both sides, each with 5 compartment dividers*

> *Also suitable for use as water-ski or wakeboard stands*



Easy to secure

High-quality swivel castors, incl. 2 with brakes, prevent the stand from rolling away unintentionally.

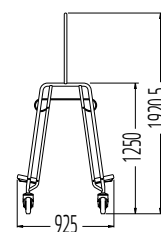
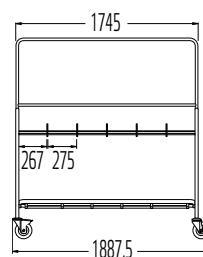

Standard equipment: Round-tube construction with supports on both sides, each with 5 wire compartment dividers.

Finish: High-gloss, galvanised, chrome-plated finish with additional transparent anti-corrosion coating.

Castors: 4 swivel castors, incl. 2 with brake. Rubber tread.

Ski and snowboard stands

Movable, with a total of 10 compartment dividers

Order no.

04.04 069.52-0000

wanzl

HEADQUARTER GERMANY
Wanzl Metallwarenfabrik GmbH
Bubesheimer Str. 4
89340 Leipheim

Phone +49 (0) 82 21 / 7 29-6529
Fax +49 (0) 82 21 / 7 29-6530

hotel@wanzl.de
www.wanzl-hotel.com

CM - 02/2013 - Dimensions in mm, specifications approximate,
colours similar to RAL, design changes reserved.
© Wanzl Metallwarenfabrik GmbH 2012

Brochure no. 1060/2012 - EN